

İNEGÖL

MYO

MOBİLYA ve DEKORASYON
PROGRAMI

ÜRÜN KATALOĞU

PRODUCT CATALOG

2025

Adres : İnegöl Meslek Yüksekokulu
Turgutalp Mah. Mahmut Esat Bey Cd. No:208
16400 İnegöl / BURSA



İMYO MOBİLYA VE DEKORASYON PROGRAMI

1995 yılında eğitim öğretim faaliyetlerine başlayan Mobilya ve Dekorasyon Programının ana amacı sektörün ihtiyaç duyduğu nitelikte teknik elemanların yetiştirilmesidir. Reel sektörün ihtiyaç ve beklentilerine göre sürekli olarak güncel tutulan müfredatı ile öğrencilere üç boyutlu tasarım, modelleme, CNC programlama eğitimleri verilmektedir. Bursa Uludağ Üniversitesi İnegöl yerleşkesi içinde Mobilya ve Dekorasyon Programına ait 2.000 m² Ahşap Uygulama Atölyesi, Makine Programına ait 1.000 m² Metal Atölyesi olmak üzere toplam 3.000 m² kapalı alanda gerçekleştirilen mobilya üretimi ile de teorik bilgilerin pratiğe aktarılmasına imkân sağlanmaktadır. Üniversitemizin talep ve ihtiyaçları göz önünde bulundurularak beklentileri üst seviyede karşılayabilecek, kaliteli, dayanıklı ve fonksiyonel ürünler tasarlanarak bu uygulama atölyelerinde üretilmektedir.

Program bünyesinde görev yapan öğretim elemanlarının mevcut görevleri öncesinde sektörün önde gelen kuruluşlarında uzun yıllar mühendis ve yönetici olarak çalışmış olmaları hem eğitim öğretim kalitesinin artmasına hem de yapılan işlerin uluslararası standartlarda olmasına imkân sağlamaktadır. Güçlü akademik kadrosu, CNC makinelerin yer aldığı endüstriyel makine parkı ve ülkemizde bir mobilya üretim merkezi haline gelen İnegöl'de bulunmanın avantajı, gerçekleştirilen faaliyetlerin başarısını olumlu yönde etkilemektedir.

Bu katalogta yer alan standart ürün gruplarının üretilmesinin yanı sıra özellikle tasarım, proje ve uygulama hizmetleri verilmektedir. Merkez kampüsümüzde ve üniversitemize bağlı tüm birimlerde amfiler, sınıflar, laboratuvarlar, sosyal alanlar, kütüphaneler, öğrenci çalışma ve dinlenme alanları, personel ofisleri, hastane içinde hasta odaları, genel mekanlar vb. daha bir çok mekana yönelik iç mekan tasarımı ve uygulama çalışmaları başarı ile yürütülmektedir. Bu kapsamda, Faik Çelik İlahiyat Fakültesi, Çamlık Yemekhanesi, Fen Edebiyat Fakültesi, İktisadi ve İdari Bilimler Fakültesi, İnegöl İşletme Fakültesi, Tıp Fakültesi, Rektörlük, Spor Bilimleri Fakültesi, Sağlık Bilimleri Fakültesi, Mühendislik Fakültesi, Eğitim Fakültesi, Mimarlık Fakültesi, Endüstri Mühendisliği, Çevre Mühendisliği, Konservatuar, İyi Hekimlik, Merkez Laboratuvar, Orhangazi MYO, Orhaneli MYO, İnegöl MYO ve Merkez Kütüphane uygulamaları son dönemde gerçekleştirilen projeli işlerden sadece bir kısmıdır.

Uygulama çalışmaları ile hem öğrencilerimizin eğitimlerine katkı sağlanmakta hem de Üniversitemizin mobilya ihtiyaçları alternatiflerine göre daha kaliteli ve daha uygun maliyetlerde karşılanabilmektedir. Yaratılan bu büyük katma değer birçok meslek yüksekokuluna da örnek olarak gösterilmektedir.

İÇİNDEKİLER

CONTENTS

01	YÖNETİCİ ODA TAKIMI
03	AKADEMİK PERSONEL ODA TAKIMI
05	İDARİ PERSONEL ODA TAKIMI
07	Yönetici Masası
07	Konsol
08	Yönetici Sehpa
08	Cam Kapaklı Evrak Dolabı
09	Elbise Dolabı
09	Akademik Personel Masası
10	Keson
10	Akademik Personel Sehpa
11	İdari Personel Masası
11	Evrak Dolabı
12	Cam Kapaklı Yarım Boy Dolap
12	Ahşap Kapaklı Yarım Boy Dolap
13	Kürsü
13	Platform Masa
13	Bilgisayar Masası
14	Toplantı Masası
14	Öğrenci Sıraları
15	TAMAMLANAN ÖZEL PROJELERDEN ÖRNEKLER
36	İLETİŞİM BİLGİLERİ





YÖNETİCİ MASASI



YÖNETİCİ SEHPASI



KONSOL



ELBİSE DOLABI



**CAM KAPAKLI
EVRAK DOLABI**







**AKADEMİK PERSONEL
MASASI**



**AKADEMİK PERSONEL
SEHPASI**



KESON



ELBİSE DOLABI



**CAM KAPAKLI
EVRAK DOLABI**







**İDARİ PERSONEL
MASASI**

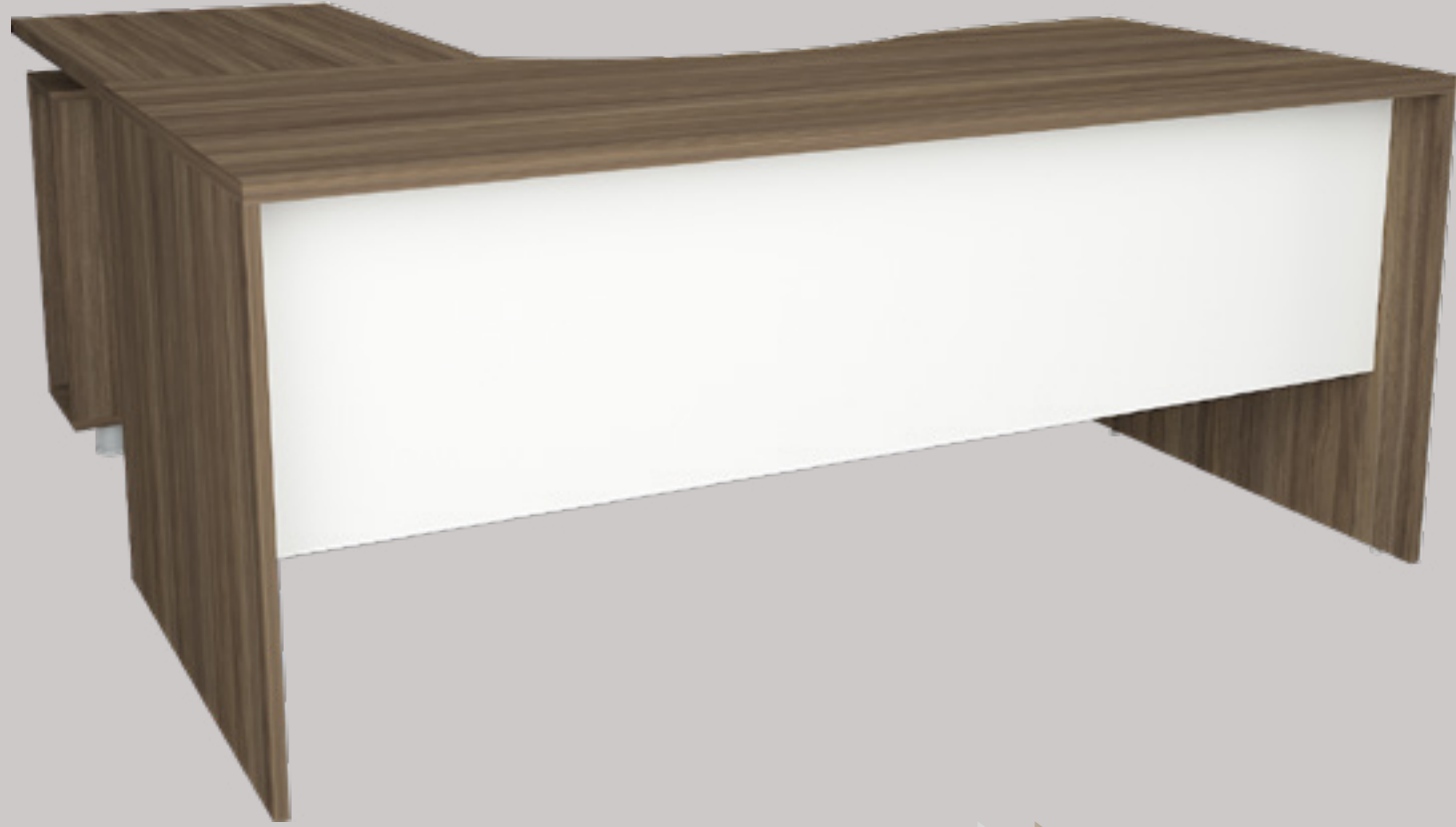

**İDARİ PERSONEL
SEHPASI**



KESON



ELBİSE DOLABI



EVRAK DOLABI



► **YÖNETİCİ MASASI**
YMS.195

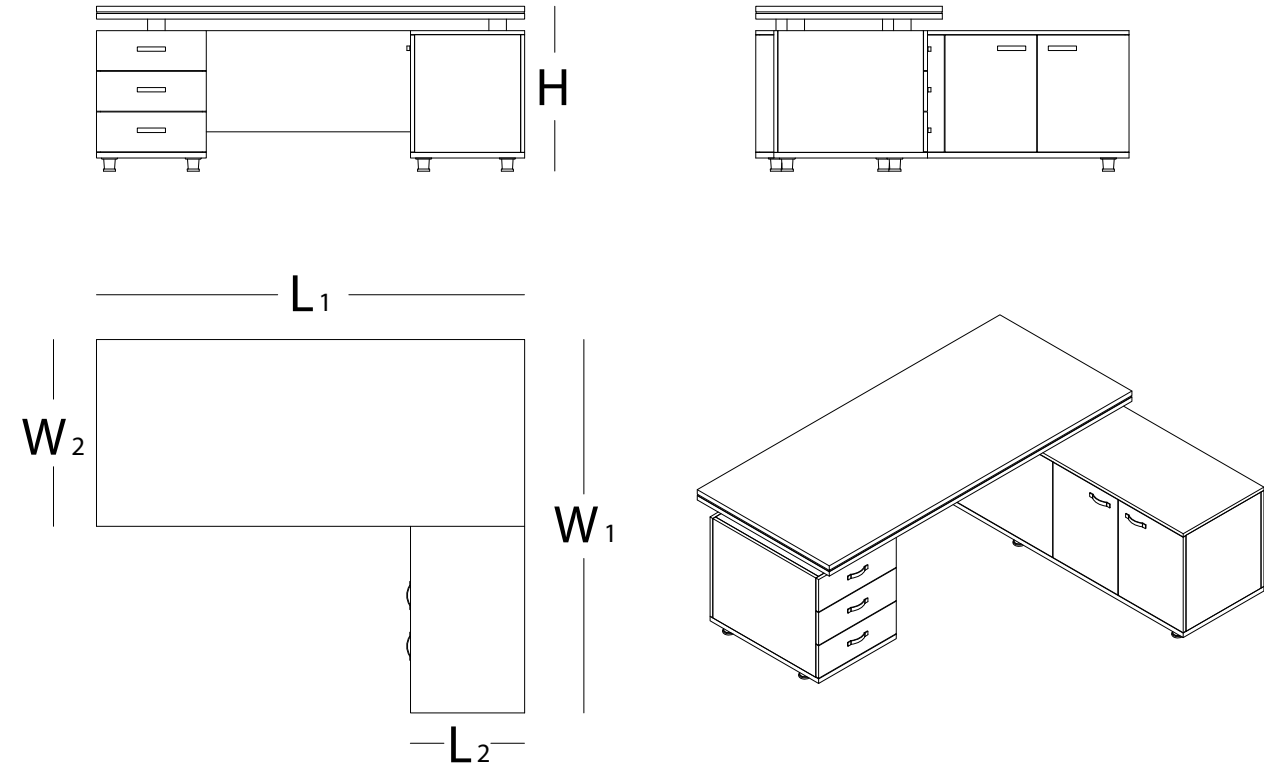

CEVİZ

EBAT

L_1 : 195
 L_2 : 52

W_1 : 170
 W_2 : 85

H : 75

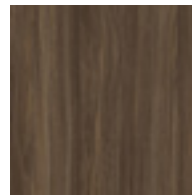

VİZON BEJ



7

KONSOL ◀
YKN.180

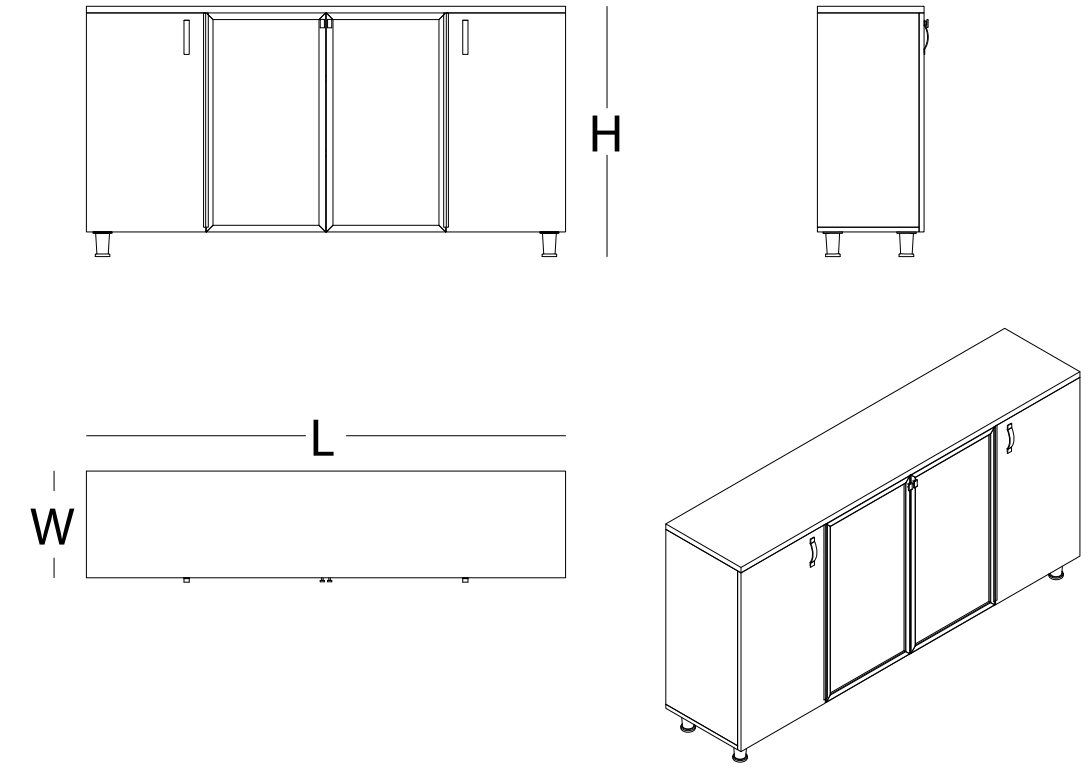

EBAT

L : 180

W : 40

H : 94

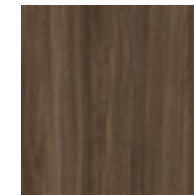

VİZON BEJ

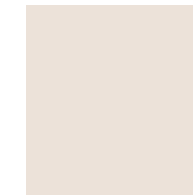

► **YÖNETİCİ SEHPASI**
YSH.070

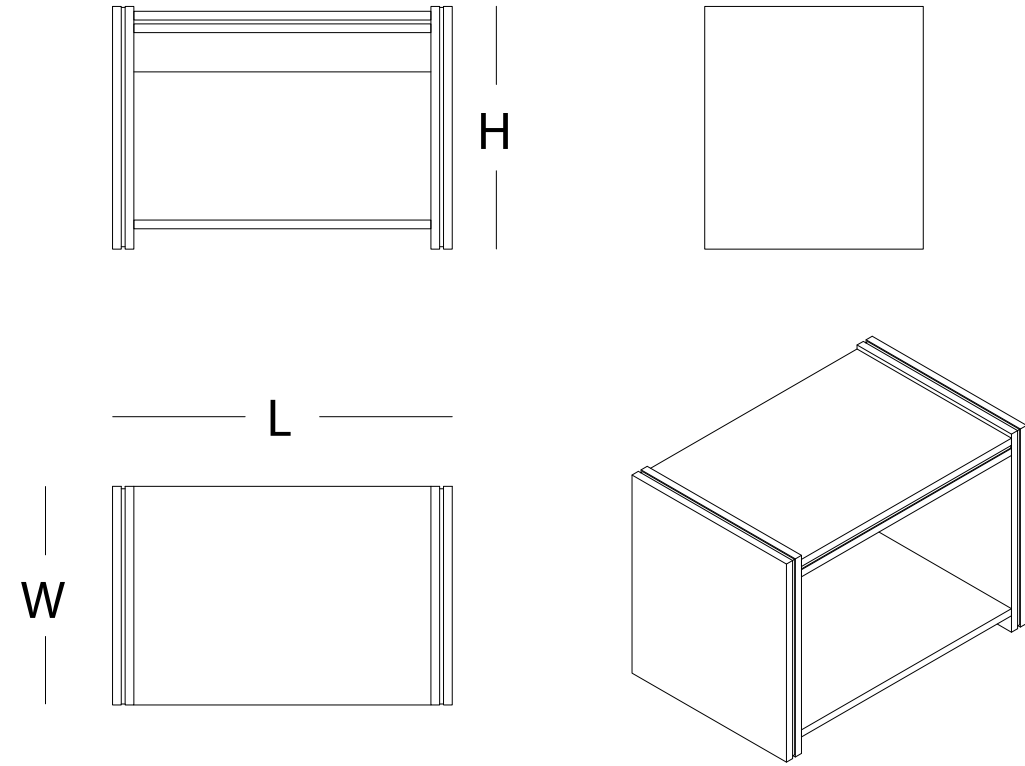

EBAT

L : 70

W : 45

H : 50



CEVİZ

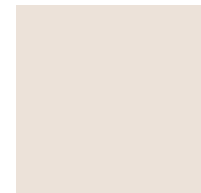

VİZON BEJ



8

CAM KAPAKLI EVRAK DOLABI ◀
EDAC.090

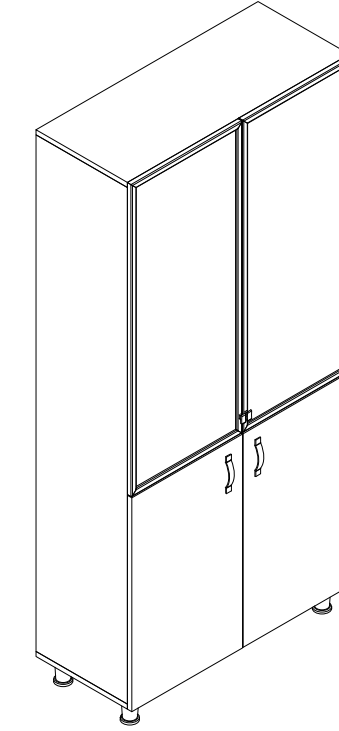
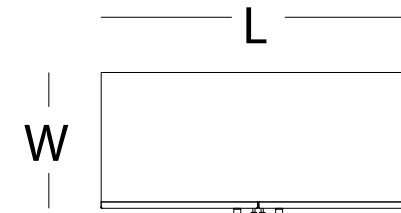
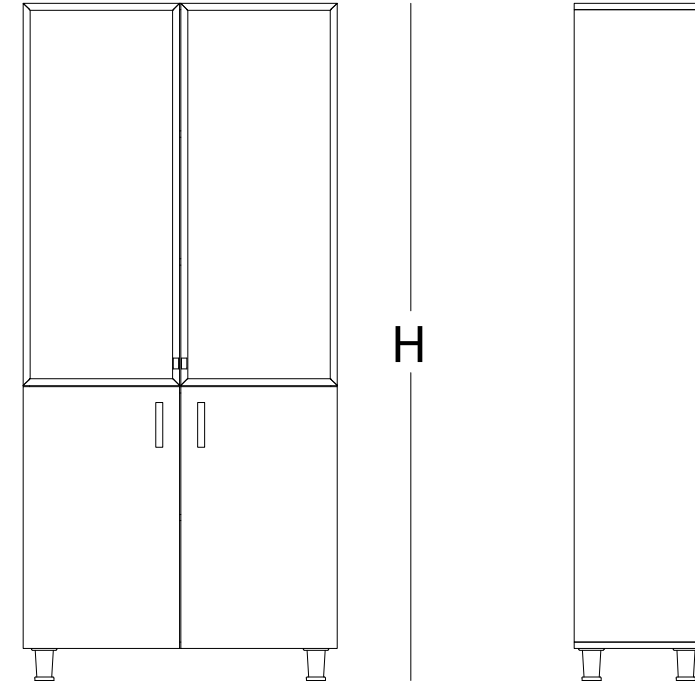

EBAT

L : 90

W : 38

H : 194



CEVİZ



VİZON BEJ



► **ELBİSE DOLABI**
GED.060

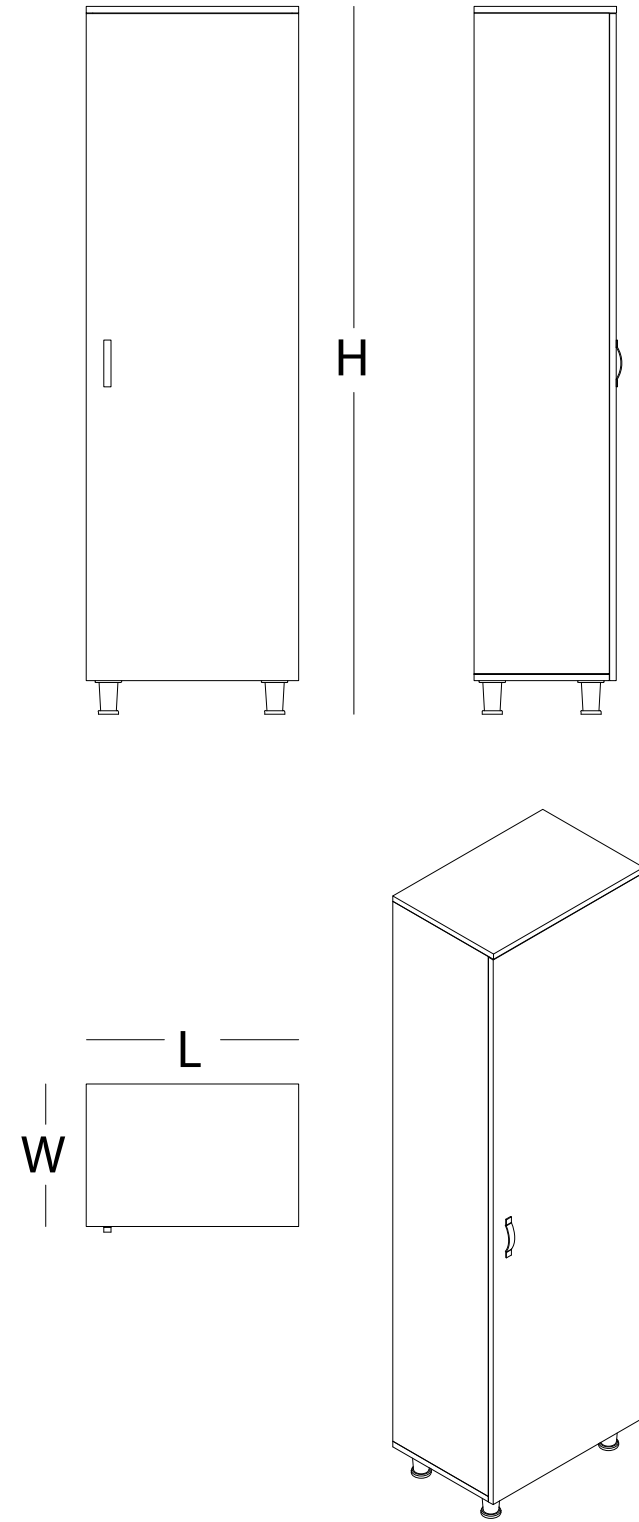

EBAT

L : 60

W : 38

H : 194

◀▶▶▶ **CEVİZ**

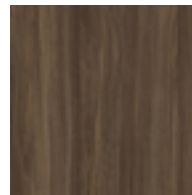

VİZON BEJ ▶▶▶▶



AKADEMİK PERSONEL MASASI ◀
AMS.165-AMS.175

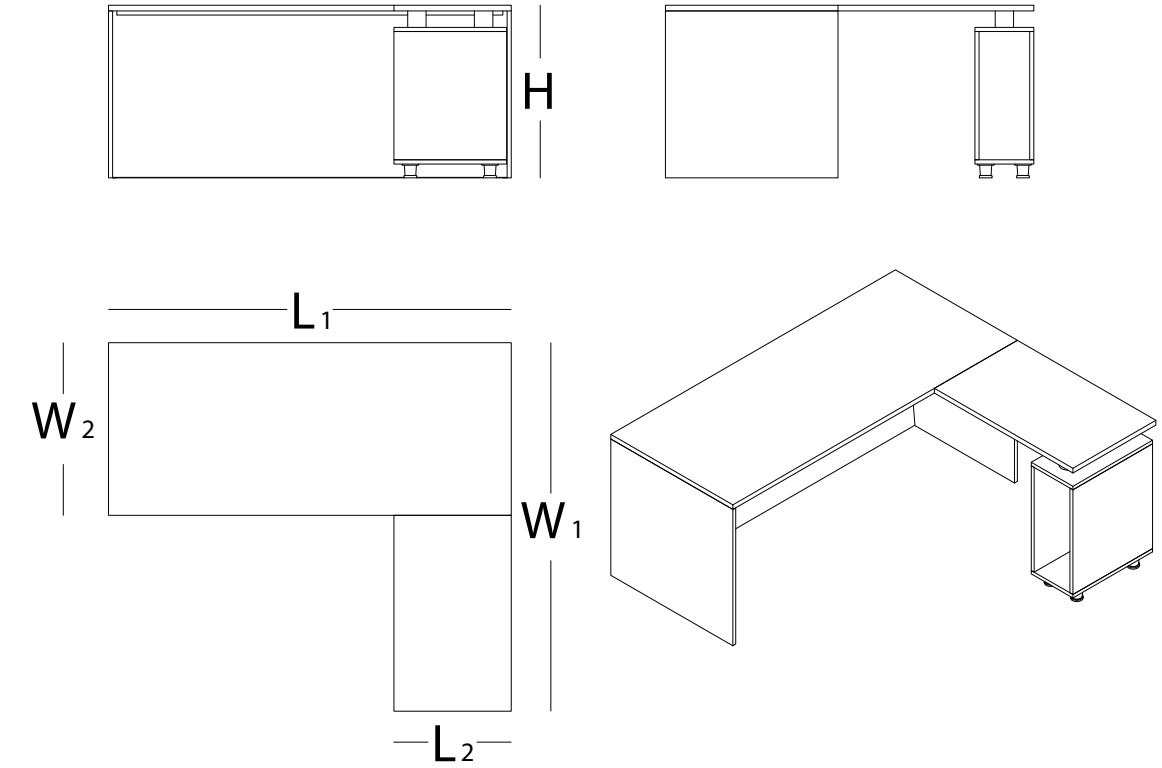

EBAT

L₁ : 160-175
L₂ : 50

W₁ : 160
W₂ : 75

H : 75

◀▶▶▶ **CEVİZ**

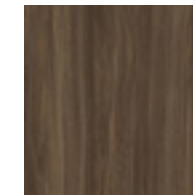

VİZON BEJ ▶▶▶▶

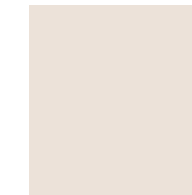

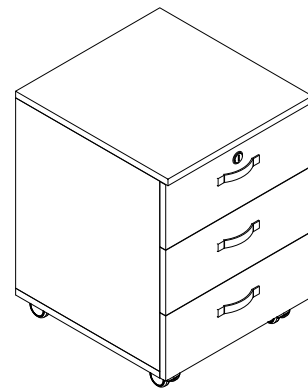
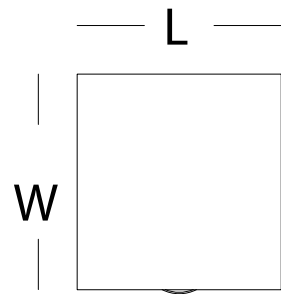
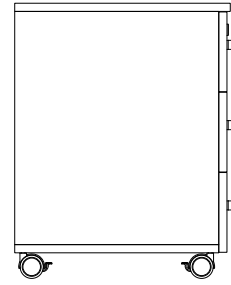
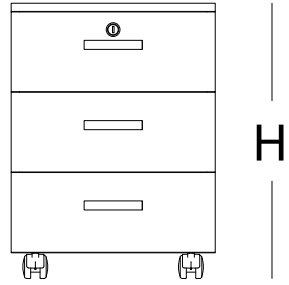

EBAT

L : 45

W : 47,5

H : 60



CEVİZ

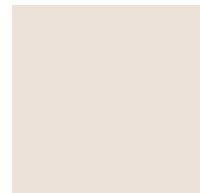

VİZON BEJ



10

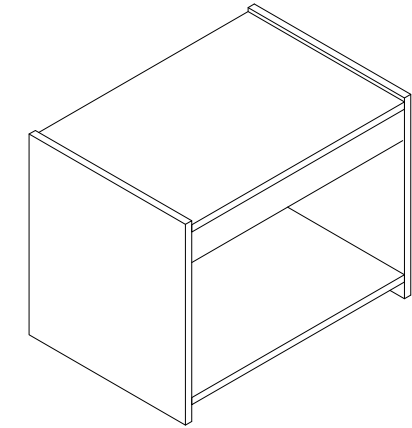
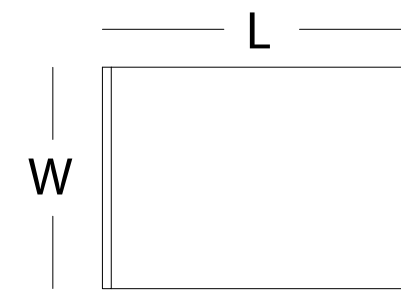
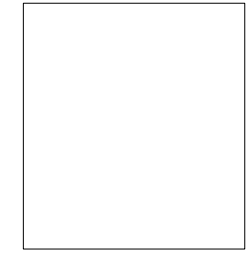
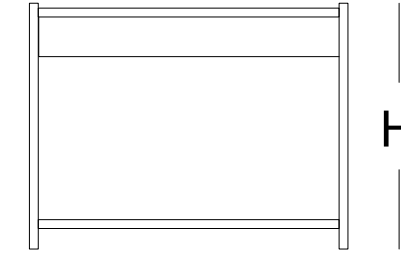

EBAT

L : 65

W : 45

H : 50

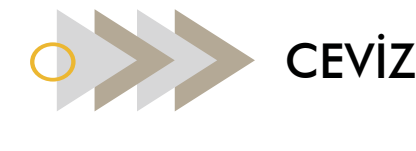

CEVİZ



VİZON BEJ



► İDARİ PERSONEL MASASI
IMS.145-IMS.165

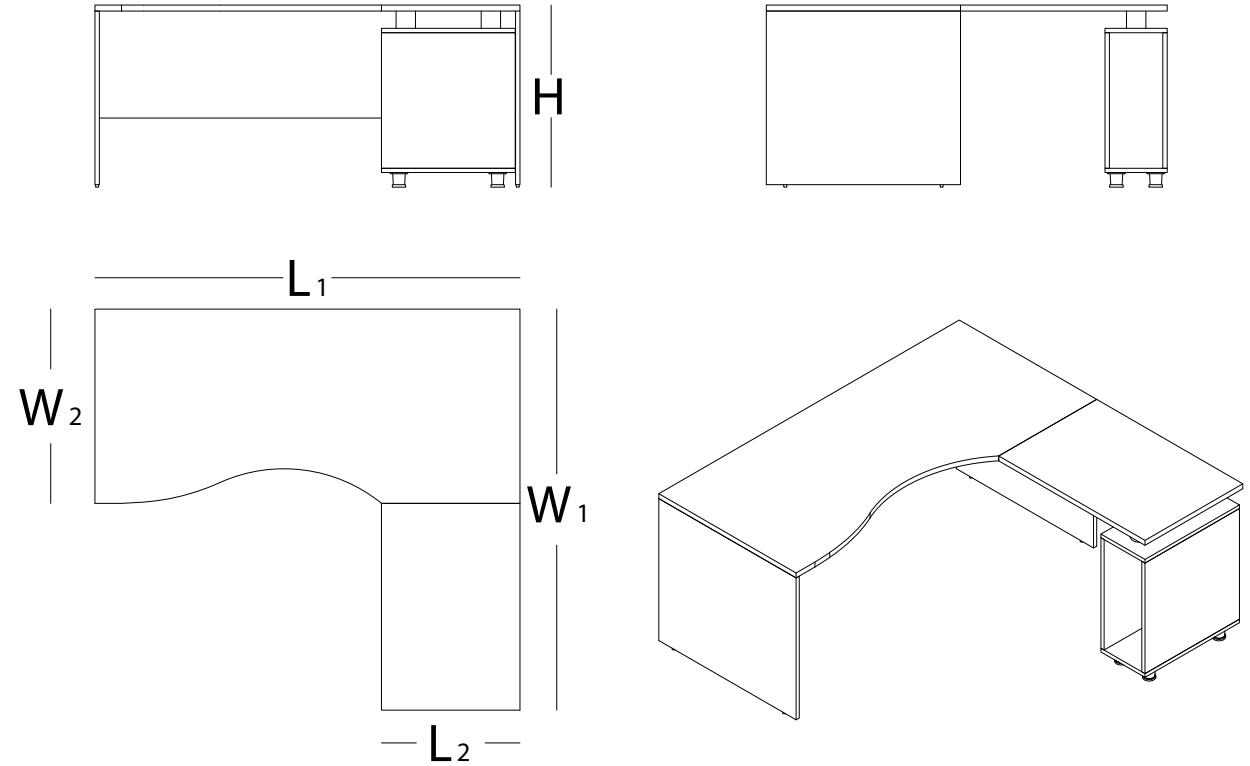

EBAT	L ₁ : 145-160	W ₁ : 160	H : 75
	L ₂ : 55	W ₂ : 80	



11

◀ EVRAK DOLABI
EDAA.090

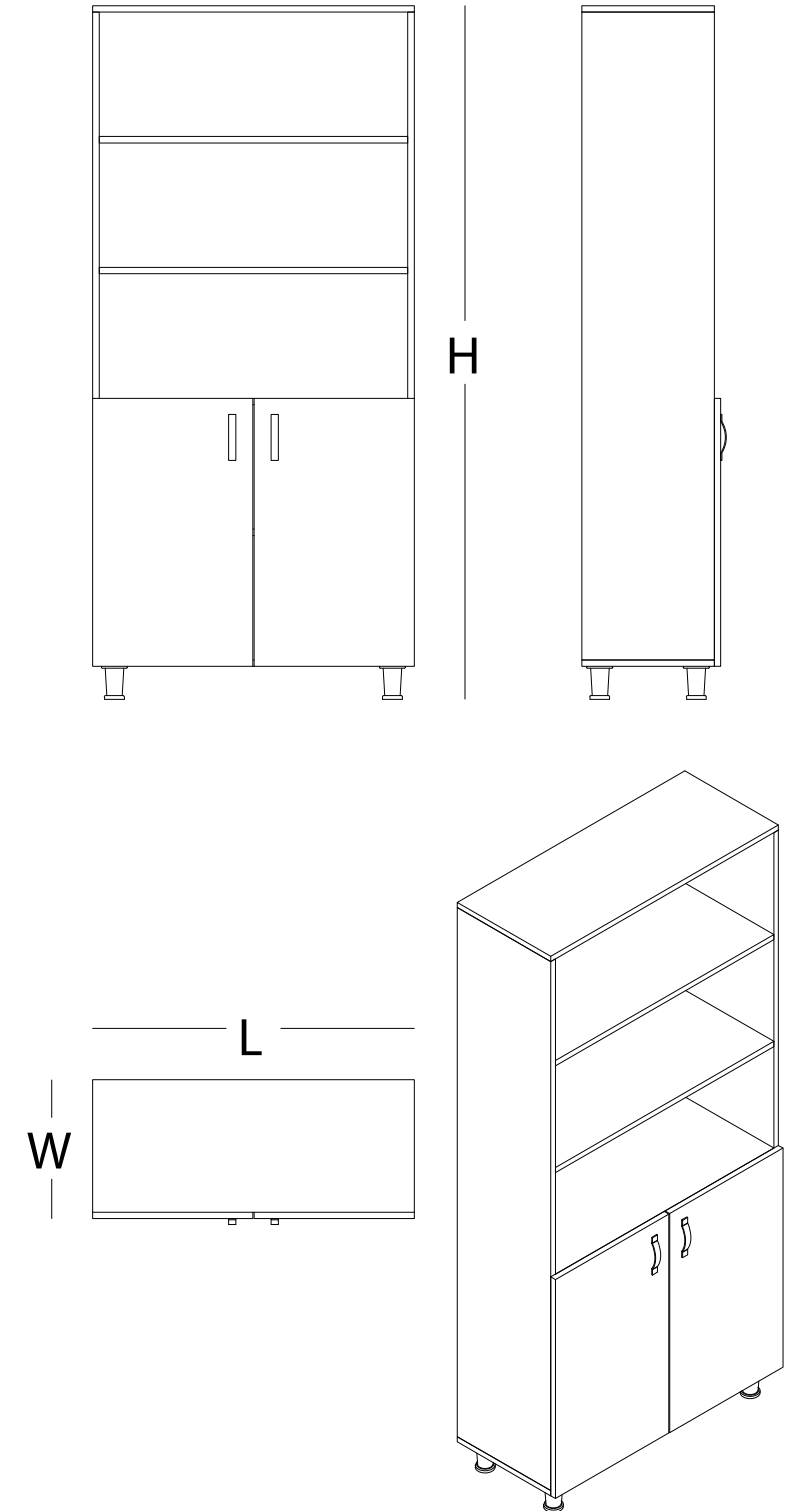

EBAT	L : 90	W : 38	H : 194
------	--------	--------	---------



► CAM KAPAKLI YARIM BOY DOLAP
YBC.080

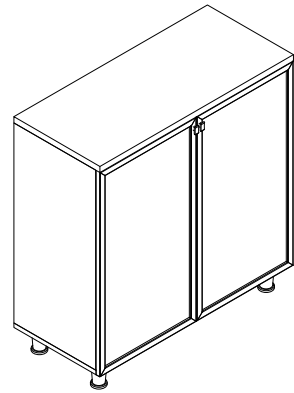
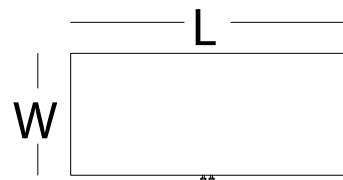
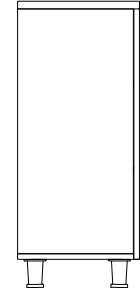
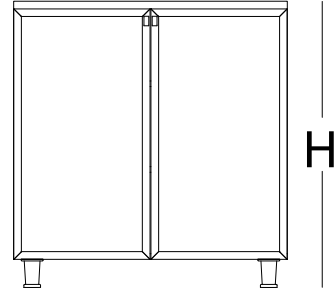

12

AHŞAP KAPAKLI YARIM BOY DOLAP
YBA.080

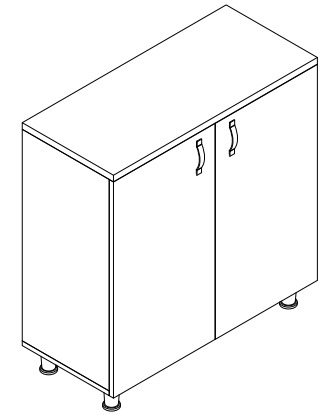
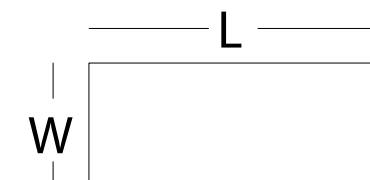
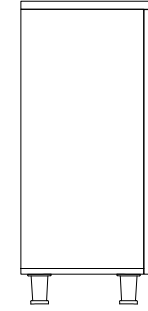
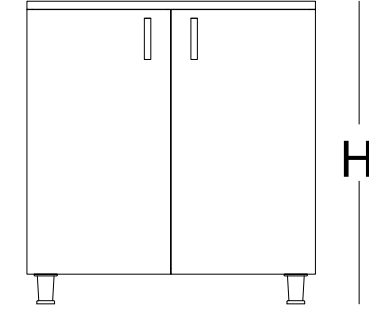

EBAT

L : 80

W : 40

H : 94

CEVİZ

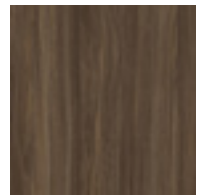

VİZON BEJ

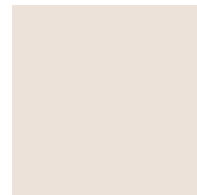

EBAT

L : 80

W : 40

H : 94

CEVİZ

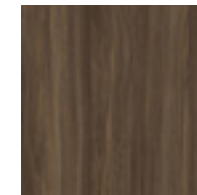

VİZON BEJ



► KÜRSÜ
KRS.001



◀ KÜRSÜ
KRS.002



13

BMS.001
BKS.001

◀ BİLGİSAYAR MASASI
BİLGİSAYAR KASASI KABİNİ



► PLATFORM MASA
PMS.001





8 KİŞLİK TOPLANTI MASASI (TPM.280)
12 KİŞLİK TOPLANTI MASASI (TPM.350)
16 KİŞLİK TOPLANTI MASASI (TPM.280)

280x75x150
350x75x150
280x75x150

2 KİŞLİK KATLANIR OTURAKLI ÖĞRENCİ SIRASI (ASK.002) 115x75x88
3 KİŞLİK KATLANIR OTURAKLI ÖĞRENCİ SIRASI (ASK.003) 165x75x88
4 KİŞLİK KATLANIR OTURAKLI ÖĞRENCİ SIRASI (ASK.004) 215x75x88





TAMAMLANAN ÖZEL PROJELERDEN ÖRNEKLER



ÇAMLIK YEMEKHANESİ





AMFİ DUVAR VE KOLON KAPLAMALARI



ALÜMİNYUM KONSTRÜKSİYONLU AHŞAP SEPERATÖR



ÖĞRENCİ ÇALIŞMA ALANI





YÜKSEK LİSANS ÇALIŞMA SALONU



TOPLANTI MASALARI

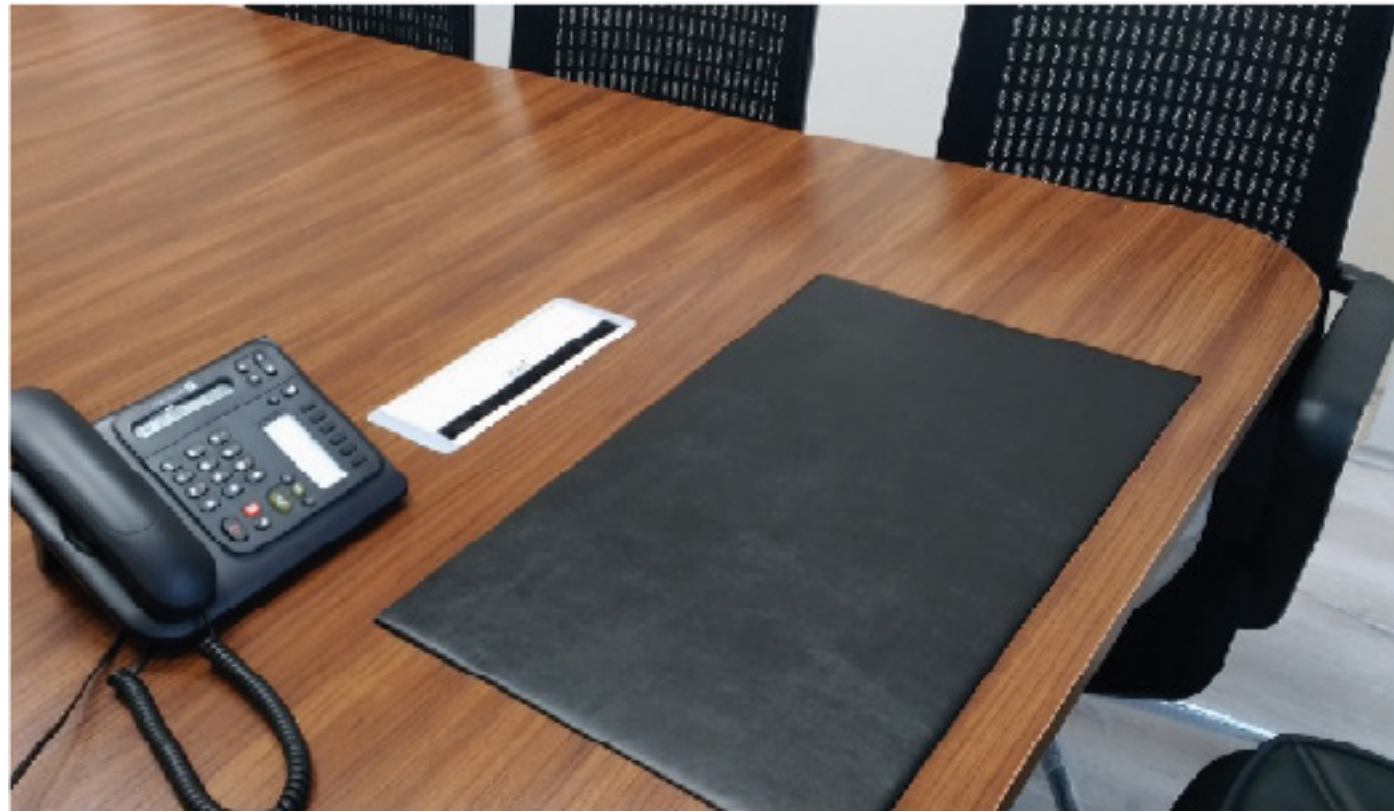





DUVAR KAPLAMALARI ve TOPLANTI MASALARI



YAZI TABLALI AKUSTİK ÖZELLİKLİ AMFİ KOLTUKLAR

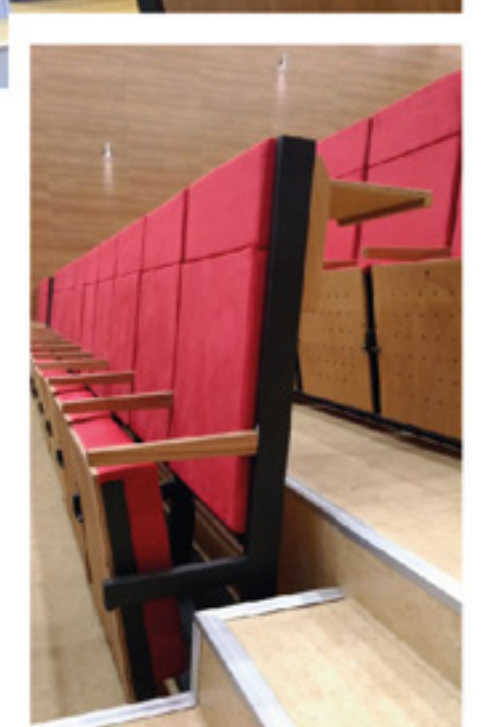
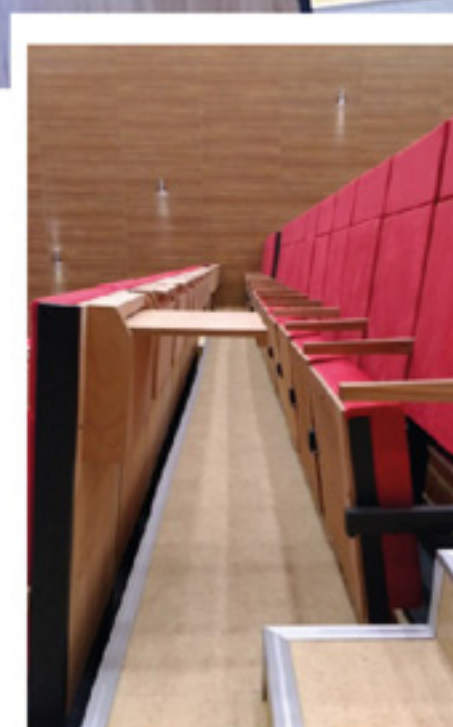
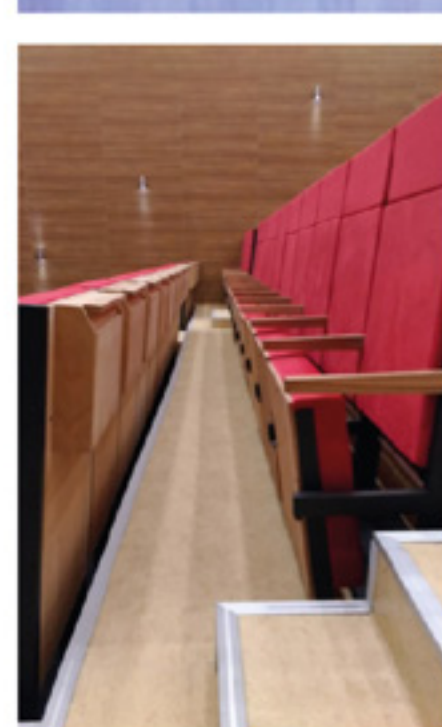

PLATFORM ve KÜRSÜLER



BANKOLAR



ÖZEL ÇALIŞMA ALANLARI ve SERGİLEME ÜNİTELERİ



BİLGİSAYAR STANDLARI





SOYUNMA DOLAPLARI

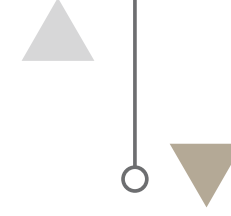

MASALAR



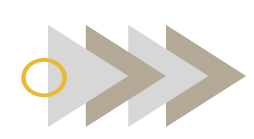

SEPERATÖRLER - DUVAR KAPLAMALARI - BANKOLAR - KAPILAR







ÖĞRENCİ SIRALARI





KİTAPLIKLAR ve SERGİLEME ÜNİTELERİ

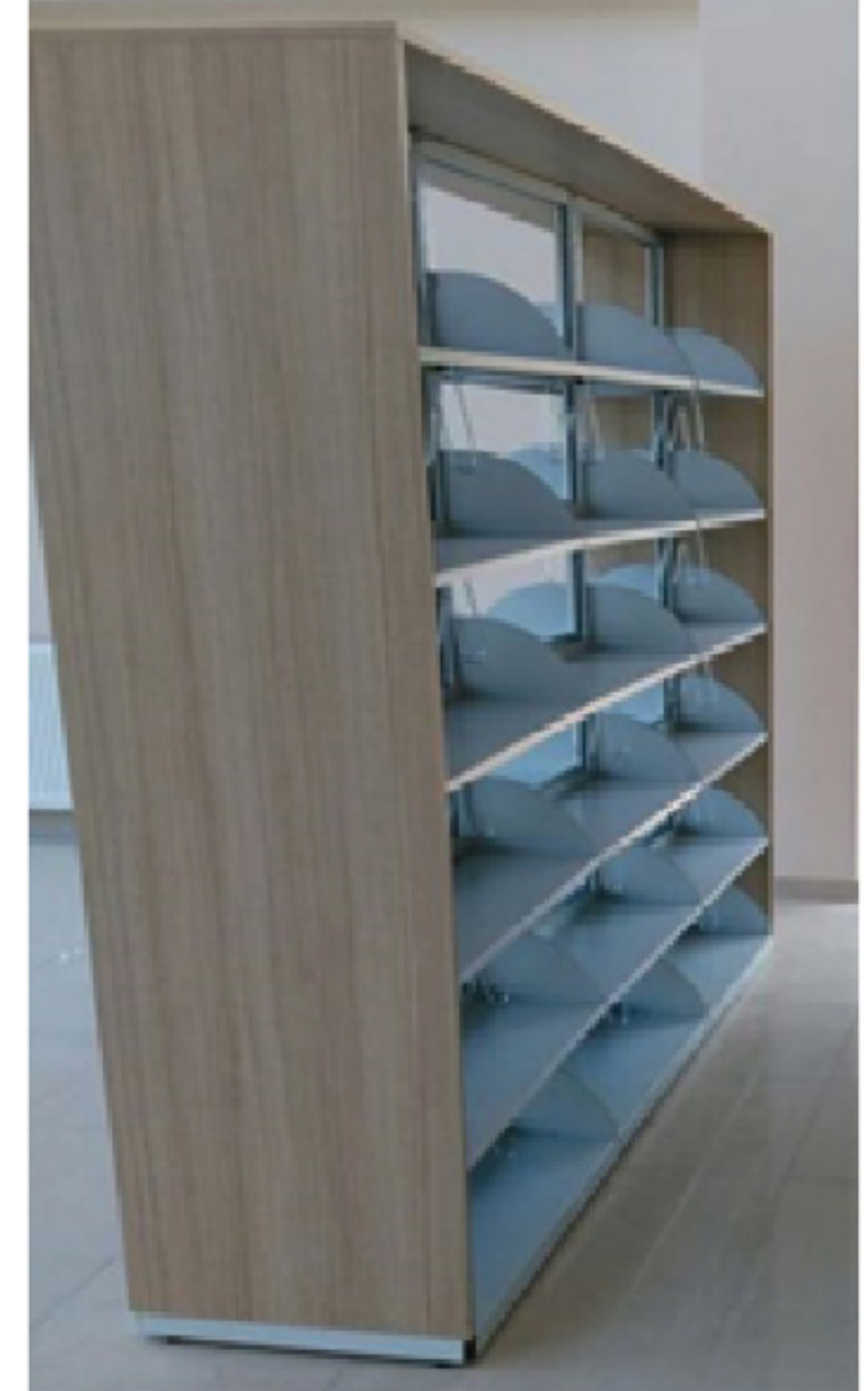

➤➤➤ AÇIK OFİSLER





ÖĞRENCİ ÇALIŞMA ALANLARI

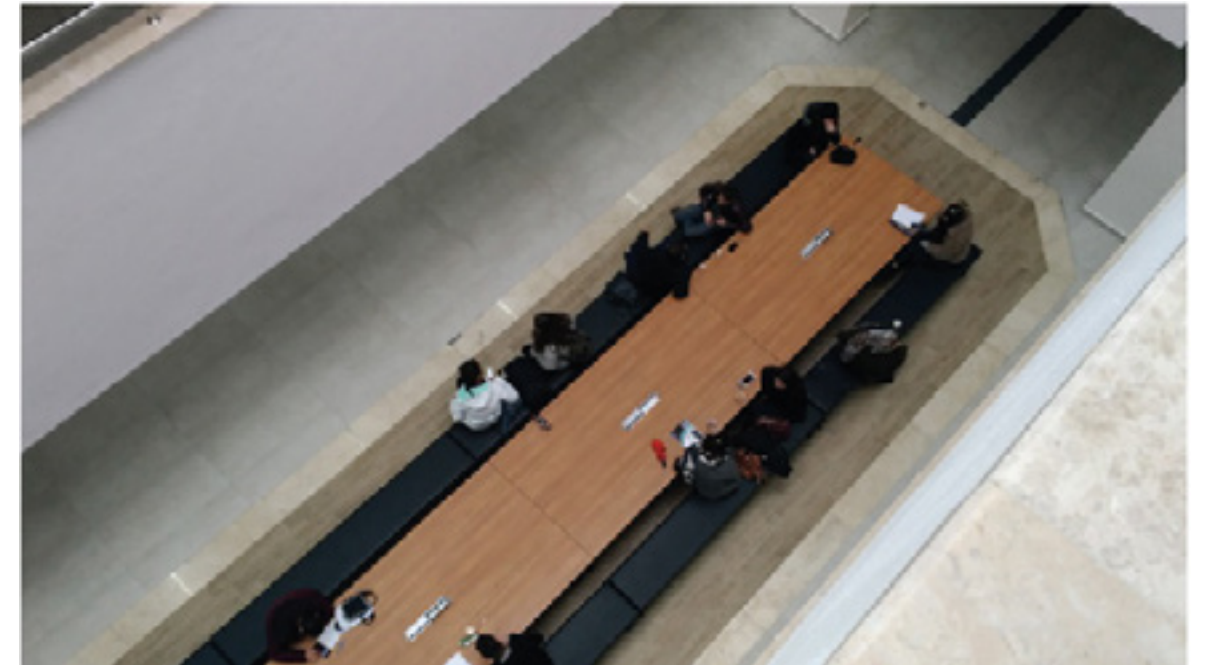
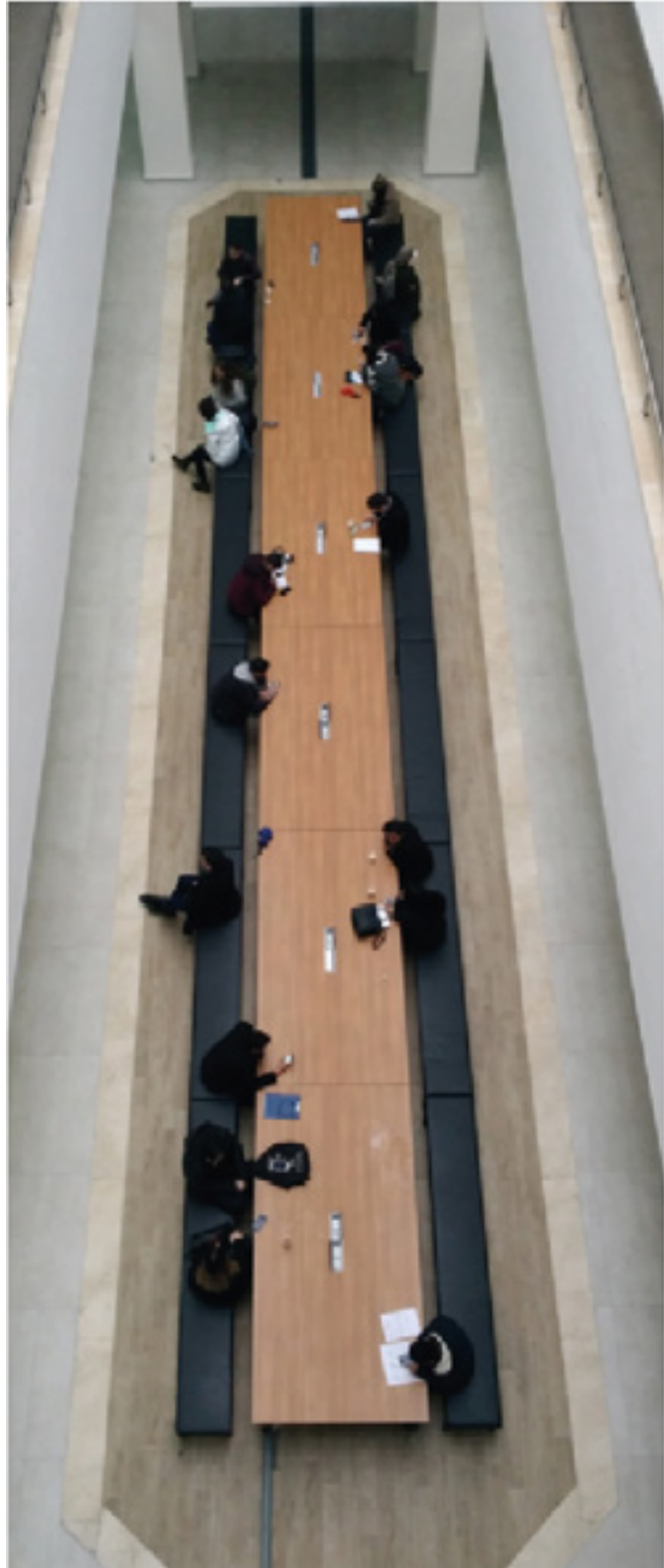

HASTA ODASI MOBİLYA TEFRİŞİ



AKUSTİK DUVAR KAPLAMALARI VE BÖLME PANELLER





ÖĞRENCİ ÇALIŞMA ALANLARI





İLETİŞİM BİLGİLERİ

Öğr. Gör. Nurettin GÖKBULUT
nurettinokbulut@uludag.edu.tr



Öğr. Gör. Dr. Eray ERSOY
erayersoy@uludag.edu.tr
0532 375 37 17



Öğr. Gör. Sezer Volkan ÖZTÜRK
volkanozturk@uludag.edu.tr



Bu kataloğun tüm hakları İMYO'ya aittir. İzinsiz kopyalanamaz ve çoğaltılamaz.
Katalogda yer alan ürünlerin hukuki ve etik sorumluluğu yazarlara aittir.
İMYO - 2025
Yayın tarihi: 29.10.2024

All rights of this catalog belong to İMYO. It may not be copied or reproduced without permission.
Legal and ethical responsibility of the product in the catalog belongs to the authors.
İMYO - 2025
Release date: 29.10.2024

Bursa Uludağ Üniversitesi
UU İnegöl MYO
Adres : İnegöl Meslek Yüksekokulu
Turgutalp Mah. Mahmut Esat Bey Cd. No:208
16400 İnegöl / BURSA
+90 224 294 26 65

